



# Low Capacitance MAX Guard® ESD Suppressor

Document No	TMS-060S001B
Issued date	2010/10/17
Page	1/8

## 1. Scope

Bi-directional MAX Guard ESD suppressors are designed for high frequency circuit applications. They are specifically produced to protect sensitive electronic circuit data lines against electrostatic discharge (ESD, as specified in IEC61000-4-2 and MIL-STD-883C). The low capacitances and leakage currents of these products are contributed by “micro air space discharge technology” designed by TA-I.

## 2. Construction

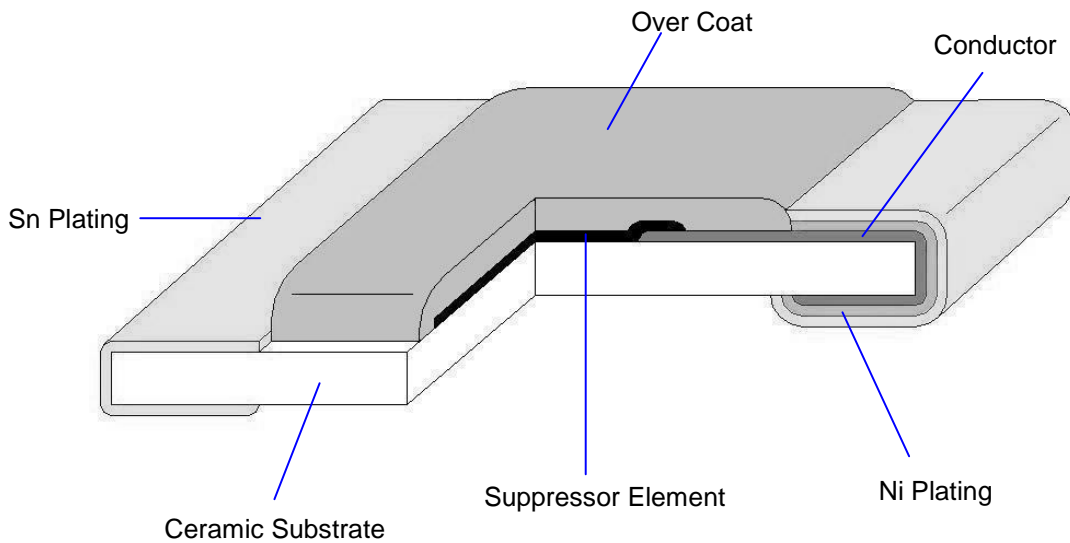

## 3. Type Designation

<b>MS</b>	<b>06</b>	<b>A</b>	<b>05</b>	<b>T</b>	<b>2</b>	<b>V2</b>
MAX Guard Suppressor	Size 06:0603(1608)	A: Suit for IEC61000-4-2 C: Suit for IEC61000-4-2 & AEC-Q200	Operating Voltage 03:3.3V 05:5.5V 12:12V 24:24V	Packaging T: Paper tape(5K/10K)	Typical Clamping Voltage 1: 17V 2: 25V	Typical Trigger Voltage V1: 150V V2: 250V



# Low Capacitance MAX Guard® ESD Suppressor

Document No	TMS-060S001B
Issued date	2010/10/17
Page	2/8

## 4. Rating and Characteristics:

Type	Continuous Operating Voltage (Max.)	ESD Capability <sup>1</sup>	Trigger Voltage (Typ.) <sup>2</sup>	Clamping Voltage (Typ.) <sup>2</sup>	Capacitance <sup>3</sup>	Leakage Current (Typ.)	Response Time	ESD Pulse Withstand (Typ.) <sup>4</sup>
MS06A03T1V1	3.3 VDC	Direct Discharge: 8KV Air Discharge: 15KV	150 V	17 V	<0.2 pF	<1nA	<1ns	>1000 pulses
MS06A03T2V2			250V	25V				
MS06A05T1V1	5.5 VDC		150 V	17 V				
MS06A05T2V2			250V	25V				
MS06A12T1V1	12 VDC		150 V	17 V				
MS06A12T2V2			250V	25V				
MS06A24T2V2	24 VDC		250V	25V				

Note:

- (1)The function meets with the requirement of IEC 61000-4-2 specification.
- (2)Trigger measurement made using Transmission Line Pulse method.
- (3)Capacitance measured at 1 M~1.8 GHz.
- (4)Performing under IEC 61000-4-2 level 4 (8KV contact discharge, 15KV air discharge).



### 5. Dimensions

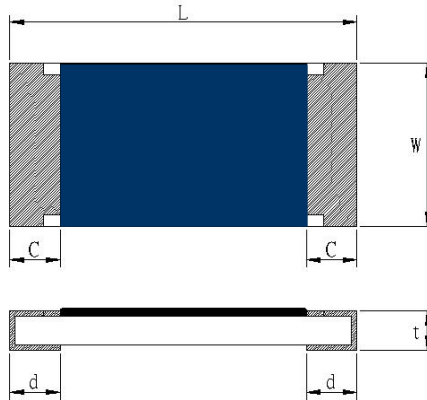

Type (Inch Size Code)	Dimensions (mm)				
	L	W	C	d	t
MS06 (0603)	1.6±0.1	0.8±0.1	0.3±0.2	0.35±0.2	0.45±0.1

### 6. Reliability Test

Environmental Specification	Reference Standard	Test Condition	Specification
Operating temperature		-55°C to 125°C	IL<1μA <sup>1</sup>
Full load voltage		1000 hrs at 85°C	
Bending		3 mm deflection	
Resistance of solder heat	MIL-STD-202 Method 210	260 ± 5°C for 10 ± 1 sec	
Thermal shock	MIL-STD-202 Method 107	-55°C to 125°C, 5 cycles	
Moisture resistance, steady state	MIL-STD-883, Method 1004.7	85%RH, 85°C for 1000hrs	
Solderability	MIL-STD-202, Method 208	245 ± 5°C solder, 2 ± 0.5 sec dwell. Solder: Sn96.5/Ag3.0/Cu0.5	95% coverage

Note: 1. IL is the simplification of Leakage Current



## 7. Taping and Reel

### 7.1 Taping Dimensions

4 mm pitch paper

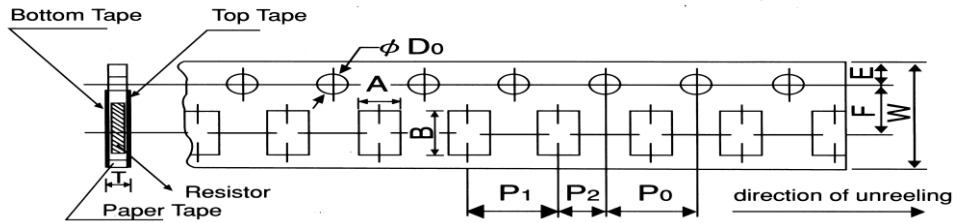

Packing	Type	A	B	W	F	E	P <sub>1</sub>	P <sub>2</sub>	P <sub>0</sub>	D <sub>0</sub>	T
Paper Tape	MS06	1.1±0.1	1.9±0.1	8.0±0.2	3.5±0.05	1.75±0.1	4.0±0.1	2.0±0.05	4.0±0.1	ψ1.5 +0.1 -0	0.64±0.1

Unit: mm

Type series		Paper Tape
		4 mm Pitch
		180mm/R
MS	06	5000

Unit: pcs



Document No	TMS-060S001B
Issued date	2010/10/17
Page	5/8

**7.2 Reel Specifications**

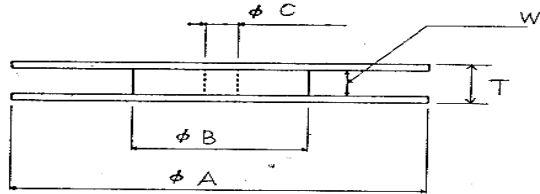
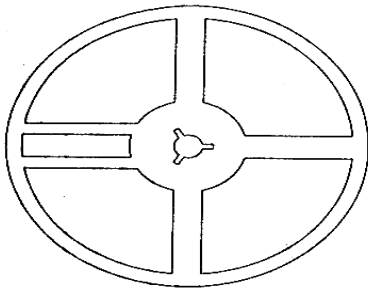

Unit: mm

Series	$\psi A$	$\psi B$	$\psi C$	W	T
MS06	$180^{+0}_{-3}$	60 min	$13.0 \pm 1.0$	$9.0 \pm 1.0$	$11.4 \pm 2.0$

**7.3 Peel –off force**

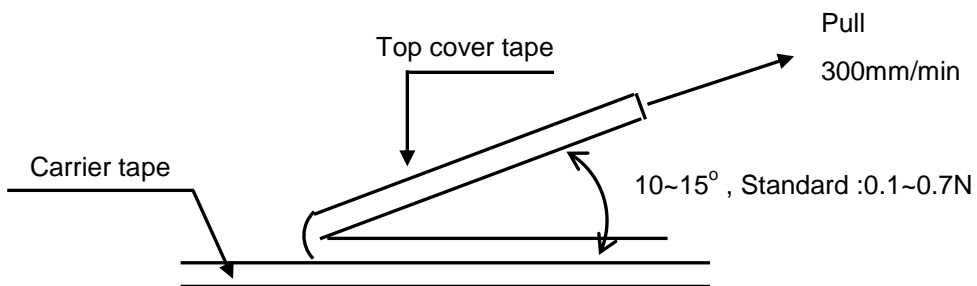

**8. Storage Conditions:**

Temperature: 5°C ~35°C, Humidity: 40%~75%

**9. Shelf Life:**

2 years from manufacturing date



**Low Capacitance MAX Guard® ESD Suppressor**

Document No	TMS-060S001B
Issued date	2010/10/17
Page	6/8

**10. Label**

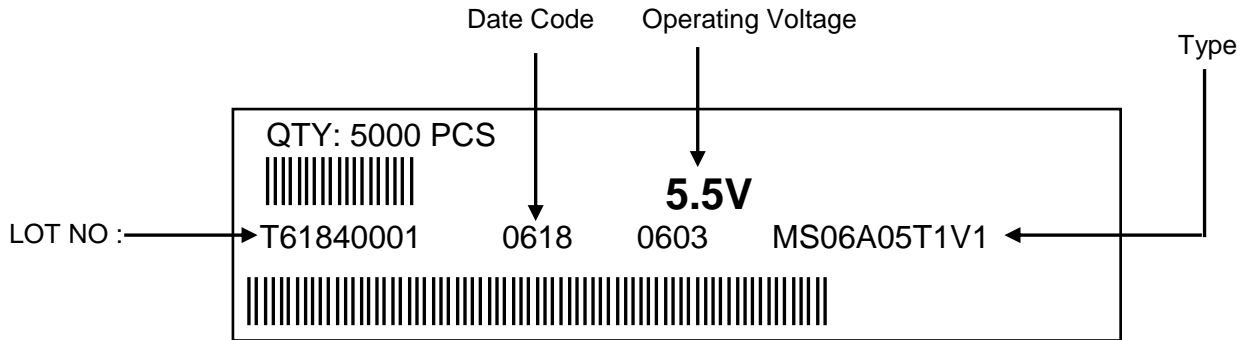

**11. Recommended land patterns**

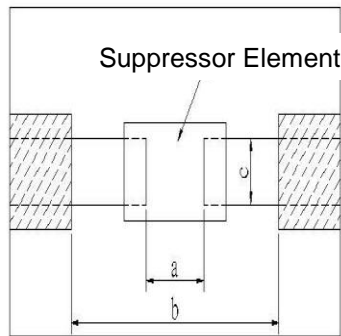

Unit: mm

Type	Land Pattern Size	Dimension		
		a	b	c
MS	06 ( 0603 )	0.7~0.9	2.0~2.2	0.8~1.0



Document No	TMS-060S001B
Issued date	2010/10/17
Page	7/8

**12. Recommend IR – Reflow profile : (solder : Sn96.5 / Ag3 / Cu0.5)**

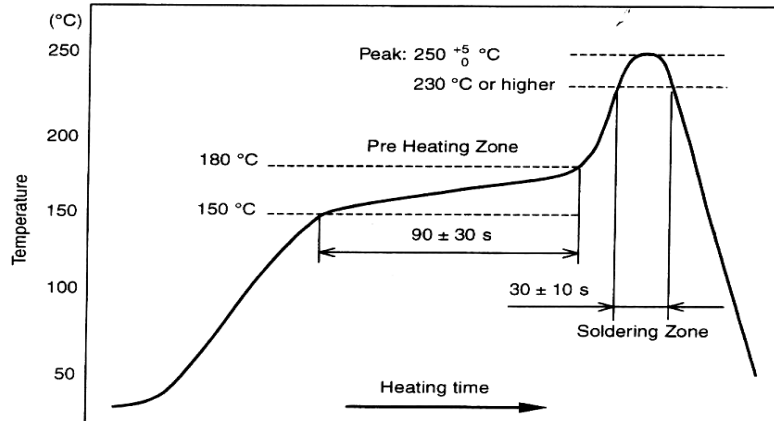

Peak :  $250 \begin{matrix} +5 \\ -0 \end{matrix} ^\circ\text{C}$  , 5 sec

Pre – heat Zone : 150 to 180°C , 90±30 sec

Soldering Zone : 230°C or higher , 30±10 sec

**13. ECN**

Engineering Change Notice: The customer will be informed with ECN if there is significant modification on the characteristics and materials described in Approval Sheet.

**14. Manufacturing Country & City :**

TA-I TECHNOLOGY CO., LTD. ( Taiwan – Tao Yuan )  
Tel: (+886)-3-3246169 Fax : (+886)-3-3246167

**Associated companies :**

(1) FORTUNE TASK RESISTOR FACTORY ( China – Dong Guan )

Tel : (+86)-769-83394790 Fax : (+86)-769-83394794

(2) TA-I TECHNOLOGY ( SU ZHOU ) CO., LTD. ( China – Su Zhou)

Tel : (+86)- 512-63457879 Fax : (+86)-512-63457869

(3) TAI OHM ELECTRONICS ( M ) SDN. BHD. ( Malaysia – Penang )

Tel : (+604)- 3900480 Fax : (+604)-3901481

(4) P.T.TAI ELECTRONICS Indonesia ( Indonesia – Jakarta )

Tel : 62-21-89830123 Fax : 62-21-89830703



Document No	TMS-060S001B
Issued date	2010/10/17
Page	8/8

15. Test Circuit Board

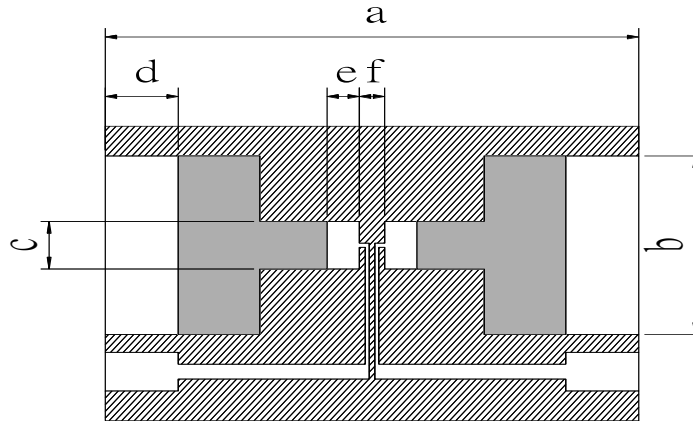

Type	a	b	c	d	e	f
MS0603	19	6	1.6	2.6	1.15	0.9

Unit: mm